

Kawasaki™

ROTARY TOOL

INSTRUCTION MANUAL

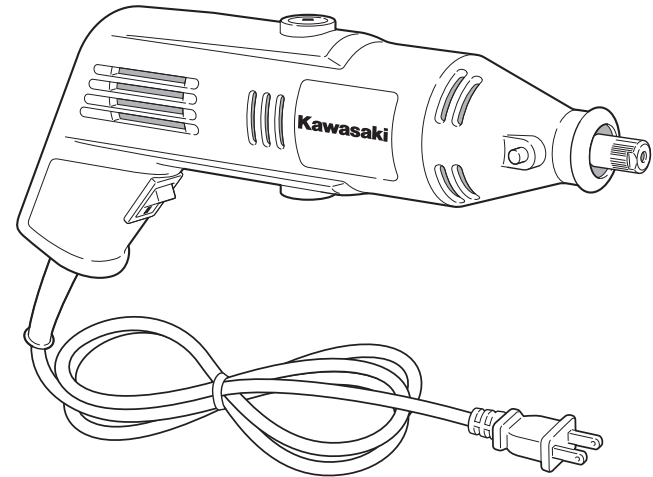

THIS MANUAL CONTAINS IMPORTANT INFORMATION REGARDING SAFETY, OPERATION, MAINTENANCE AND STORAGE OF THIS PRODUCT. BEFORE USE, READ CAREFULLY AND UNDERSTAND ALL CAUTIONS, WARNINGS, INSTRUCTIONS AND PRODUCT LABELS. FAILURE TO DO SO COULD RESULT IN SERIOUS PERSONAL INJURY AND/OR PROPERTY DAMAGE.

IF YOU SHOULD HAVE ANY QUESTIONS OR EXPERIENCE A PROBLEM WITH YOUR ALLTRADE PRODUCT, DO NOT RETURN THIS PRODUCT TO THE STORE. PLEASE CALL OUR CUSTOMER SERVICE DEPARTMENT AT **1-800-590-3723**. BEFORE YOU CALL, HAVE THE FOLLOWING INFORMATION AVAILABLE: MODEL No., DATE PURCHASED AND STORE LOCATION. AN ALLTRADE REPRESENTATIVE CAN RESOLVE YOUR PROBLEM OVER THE PHONE. IF YOU WOULD LIKE TO MAKE A SUGGESTION OR COMMENT, GIVE US A CALL OR EMAIL US AT: INFO@ALLTRADETOOLS.COM. YOUR FEEDBACK IS VITAL TO US.

FOR CUSTOMER SERVICE
POUR LE SERVICE APRÈS VENTE
OU DU CONSOMMATEUR
PARA EL SERVICIO
PARA EL CONSUMIDOR
1-800-590-3723

Printed in China

Kawasaki

Kawasaki Motors Corp., U.S.A.

OFFICIAL • LICENSED • PRODUCT

87-1904-60957

KAWASAKI™ IS A TRADEMARK LICENSED BY KAWASAKI™ MOTORS CORP., U.S.A., WHICH DOES NOT MANUFACTURE OR DISTRIBUTE THIS PRODUCT. CONSUMER INQUIRES SHOULD BE DIRECTED TO:

©COPYRIGHT 2006 ALLTRADE TOOLS, LLC.
1431 VIA PLATA
LONG BEACH, CA 90810-1462 USA

840589 – Electric Rotary Tool_Rev 12/21/06

TABLE OF CONTENTS

CONGRATULATIONS!	2
INTENDED USE	2
SECTION ONE	
GENERAL SAFETY RULES	2
RECOGNIZE SAFETY SYMBOLS, WORDS AND LABELS	2-3
IMPORTANT SAFEGUARDS	3
WORK AREA	4
ELECTRICAL SAFETY	4
PERSONAL SAFETY	5
TOOL USE AND CARE	5-6
SERVICE	6
SECTION TWO	
SPECIFIC SAFETY RULES AND/OR SYMBOLS	6
IMPORTANT SAFETY RULES FOR ROTARY TOOLS	6-8
SYMBOLS	8
SECTION THREE	
FUNCTIONAL DESCRIPTION	9
ASSEMBLY	9
OPERATING INSTRUCTIONS	10-11
OPERATING SPEEDS	10-11
SECTION FOUR	
MAINTENANCE AND CLEANING	11-12
ACCESSORIES	12
INSERTING/REMOVING ACCESSORIES	13
COLLET SIZES	13
BALANCING	14
CONNECTING FLEXIBLE SHAFT TO TOOL (MODELS 840168 AND 840169)	14-15
CHANGING COLLET AND ACCESSORIES IN FLEXIBLE SHAFT	15
INSTALLING RIGHT ANGLE ATTACHMENT (MODELS 840168 AND 840169)	15-16
ASSEMBLE ROTARY TOOL STAND (MODEL 840169)	17
TYPES OF ACCESSORIES	18-20

SPECIFICATIONS	20
OTHER CONSUMER DO-IT-YOURSELF (DIY) TOOLS	20

SECTION FIVE

3 YEAR LIMITED WARRANTY	21-24
-------------------------------	-------

CONGRATULATIONS!

Thanks for choosing this product. At Alltrade, our aim is to provide you with quality products at an affordable price, and we want you to be totally satisfied with your product and our Customer Service. If any help and advice is needed, please contact us at 1-800-590-3723. Properly cared for, this tool will give you many years of satisfaction.

INTENDED USE

This tool is intended for consumer use only.

GENERAL SAFETY RULES

 **WARNING** **READ AND UNDERSTAND ALL INSTRUCTIONS.** Failure to follow all instructions listed below may result in electric shock, fire and/or serious personal injury.

RECOGNIZE SAFETY SYMBOLS, WORDS AND LABELS

The safety instructions provided in this manual are not intended to cover all possible conditions and practices that may occur when operating, maintaining and cleaning power tools.

Always use common sense and pay particular attention to all the **DANGER**, **WARNING**, **CAUTION** and **NOTE** statements of this manual.



This is the safety alert symbol. It is used to alert you to potential personal injury hazards. Obey all safety messages that follow this symbol to avoid possible injury or death.



DANGER indicates an imminently hazardous situation which, if not avoided, will result in death or serious injury.

⚠ WARNING

WARNING indicates a potentially hazardous situation which, if not avoided, could result in death or serious injury.

⚠ CAUTION

CAUTION indicates a potentially hazardous situation which, if not avoided, may result in minor or moderate injury.

CAUTION

CAUTION used without the safety alert symbol indicates a potentially hazardous situation which, if not avoided, may result in property damage.

NOTE

NOTE provides additional information that is useful for proper use and maintenance of this tool. If a NOTE is indicated make sure it is fully understood.

IMPORTANT SAFEGUARDS

⚠ DANGER

People with electronic devices, such as pacemakers, should consult their physician(s) before using this product. Operation of electrical equipment in close proximity to a heart pacemaker could cause interference or failure of the pacemaker.

Some dust created by grinding, drilling, sawing, sanding, and other construction activities contains chemicals known to the State of California to cause cancer, birth defects or other reproductive harm. Some examples of these chemicals are:

- Lead from lead-based paints.
- Crystalline silica from bricks and cement and other masonry products, and arsenic and chromium from chemically-treated lumber.

Your risk from these exposures varies, depending on how often you do this type of work. To reduce your exposure to these chemicals: work in a well ventilated area, and work with approved safety equipment, such as dust masks that are specially designed to filter out microscopic particles.

Handling the power cord on corded products may expose you to lead, a chemical known to the State of California to cause cancer and birth defects or other reproductive harm. *Wash hands after handling.*

WORK AREA

⚠ WARNING

Keep your work area clean and well lit. Cluttered work benches and dark work areas may cause accidents or injury.

Do not operate power tools in explosive areas, such as in the presence of flammable liquids, gases or dust. Power tools create sparks which may ignite the dust or fumes.

Keep bystanders, children and visitors away while operating a power tool. Distractions can cause you to lose control.

ELECTRICAL SAFETY

⚠ WARNING

Double insulated tools are equipped with a polarized plug (one blade is wider than the other.) This plug will fit in a polarized outlet only one way. If the plug does not fit fully in the outlet, reverse the plug. If it still does not fit, contact a qualified electrician to install a polarized outlet. Do not change the plug in any way. Double insulation eliminates the need for the three wire grounded power cord and grounded power supply system.

Avoid body contact with grounded surfaces such as pipes, radiators, ranges and refrigerators. There is an increased risk of electric shock if your body is grounded.

Don't expose power tools to rain or wet conditions. Water entering a power tool will increase the risk of electric shock.

Do not abuse the cord. Never use the cord to carry the tool or pull the plug from an outlet. Keep the cord away from heat, oil, sharp edges, or moving parts. Replace damaged cords immediately. Damaged cords increase the risk of electric shock.

When operating the tool outside, use an outdoor extension cord marked "W-A" or "W." These cords are rated for outdoor use and reduce the risk of electric shock.

PERSONAL SAFETY

WARNING

Stay alert, watch what you are doing, and use common sense when operating a power tool. Do not use tool while tired or under the influence of drugs, alcohol or medication. A moment of inattention while operating power tools may result in serious personal injury.

Dress properly. Do not wear loose clothing or jewelry. Contain long hair. Keep your hair, clothing, and gloves away from moving parts. Loose clothes, jewelry or long hair can be caught in moving parts.

Avoid accidental starting. Be sure switch is off before plugging in. Carrying tools with your finger on the switch or plugging in tools that have the switch on invites accidents.

Remove adjusting keys or wrenches before turning the power tool "ON". A wrench or a key that is left attached to a rotating part of the power tool may result in personal injury.

Do not overreach. Keep proper footing and balance at all times. Proper footing and balance enables better control of the power tool in unexpected situations.

Use safety equipment. Always wear eye protection. Dust mask, non-skid safety shoes, hard hat or hearing protection must be used for appropriate conditions.

TOOL USE AND CARE

CAUTION

Use clamps or other practical ways to secure and support the workpiece to a stable platform. Holding the work by hand or against your body is unstable and may lead to loss of control.

Do not force tool. Use the correct tool for your application. The correct tool will do the job better and safer at the rate for which it is designed.

Do not use the tool if the power switch does not turn it "ON" or "OFF". Any tool that cannot be controlled with the switch is dangerous and must be repaired.

Disconnect the power cord plug from the power source before making any adjustments, changing accessories or storing the tool. Such preventive safety measures reduce the risk of starting the tool accidentally.

Store idle tools out of reach of children and other untrained persons. Tools are dangerous in the hands of untrained users.

CAUTION

Maintain tools with care. Keep cutting tools sharp and clean. Properly maintained tools with a sharp cutting edge are less likely to bind and are easier to control.

Check for misalignment or binding of moving parts, breakage of parts, and any other condition that may affect the tool's operation. If damaged, have the tool serviced before using.

Use only accessories that are recommended by the manufacturer for your model. Accessories that may be suitable for one tool, may become hazardous when used on another tool.

SERVICE

Tool service must be performed only by qualified repair personnel. Service or maintenance performed by unqualified personnel could result in a risk of injury.

When servicing a tool, use only identical replacement parts. Follow instructions in the Maintenance section of this manual. Use of unauthorized parts or failure to follow Maintenance Instructions may create a risk of shock or injury.

SPECIFIC SAFETY RULES AND/OR SYMBOLS

WARNING

Hold tool by insulated gripping surfaces when performing an operation where the cutting tool may contact hidden wiring. Contact with a "live" wire will also make exposed metal parts of the tool "live" and shock the operator.

IMPORTANT SAFETY RULES FOR ROTARY TOOLS

WARNING

Always wear safety goggles or eye protection when using this tool. Use a dust mask or respirator for applications which generate dust.

Secure the material being worked on. Never hold it in your hand or across your legs. Unstable support can cause loss of control and injury.

When using the Rotary Tool, always maintain a firm grip on the tool with both hands. Never put your hands or feet in the cutting area. Do not grasp the tool or place your hands too close to the bit. Keep your hands well away from the bit. Never reach underneath the tool while the bit is in motion. Do not use your legs or feet to stabilize the work piece.

⚠ WARNING

Always unplug the power cord before making any adjustments or attaching accessories.

Be careful not to accidentally trip the power switch when setting the tool down or picking the tool up.

Always hold the tool by its insulated gripping surfaces when cutting in areas that may contain hidden live wiring. If the bit makes contact with a live wire, the metal parts of this tool may conduct enough electricity to seriously shock the user. *Contact with a "live" wire will make exposed metal parts of the tool "live" and shock the operator. Do not cut or break into existing walls or other blind areas where electrical wiring may exist. If this situation is unavoidable, disconnect all fuses or circuit breakers feeding this worksite.*

Check to see that keys and adjusting wrenches are removed from the Rotary Tool before switching the tool "ON". Keys or wrenches can fly away at high velocity striking you or a bystander.

Do not use the Rotary Tool if it has been damaged, left outdoors in the rain, snow, wet or damp environments, or immersed in liquid.

Check the speed rating on all accessories. Accessories must never be run at a higher speed than they were designed to handle.

When using wire or bristle brushes, always wear protective gloves and a face shield. These brushes should never be run at speeds greater than 15,000 RPM.

Always run brushes at operating speed for a minute before using to eject loose wires and bristles. Be sure that the discharge is pointed away from you. Make sure no one is standing in front or in line with the brush.

Do not apply heavy pressure to wire or bristle brushes. This will only cause damage and/or personal injury. Brushes work best when applied lightly.

Do not use a wheel that may be damaged. If the tool or wheel is dropped, install a new wheel before continuing. Avoid bouncing and snagging the wheel as this may lead to cracking or chipping.

Do not sand or grind near flammable materials.

Handle sharp bits with care.

Never place hands near the spinning bit.

Never start the tool while bit is engaged in the material.

Always feed the bit into the material in the same direction that the chips are thrown.

⚠ WARNING

If the bit becomes jammed in the workpiece, turn the tool off at the switch. Once all moving parts have come to a stop, unplug the tool and work the bit free.

Never lay the tool down until the motor has come to a complete standstill. A running tool should not be left unattended.

Never touch the collet or bit immediately after use.

To prevent short circuits, clean the tool's vents regularly with compressed air.

Do not alter or misuse tool.

This drill is not a dental tool. Do not use on the teeth of animals or humans.

SYMBOLS

IMPORTANT: Some of the following symbols may be used on your tool. Please study them and learn their meaning. Proper interpretation of these symbols will allow you to operate the tool better and safer.

SYMBOL	NAME	EXPLANATION
V	Volts	Voltage (Potential)
A	Amperes	Current
Hz	Hertz	Frequency (Cycles per Second)
W	Watt	Power
Kg	Kilograms	Weight
~	Alternating Current	Type of Current
— — —	Direct Current	Type of Current
~ — —	Alternating or Direct Current	Type of Current
⊕	Earthing Terminal	Grounding Terminal
⊞	Class II Construction	Denotes Double Insulation
min	Minutes	Time
s	Seconds	Time
φ	Diameter	Size of Drill Bits, Grinding Wheels, etc.
n_0	No load speed	No-load Rotational Speed
.../min	Revolutions per Minute	Revolutions, Surface Speed, Strokes, etc. per Minute
1,2,3, ...	Ring Selector Settings	Speed, Torque or Position Settings

FUNCTIONAL DESCRIPTION

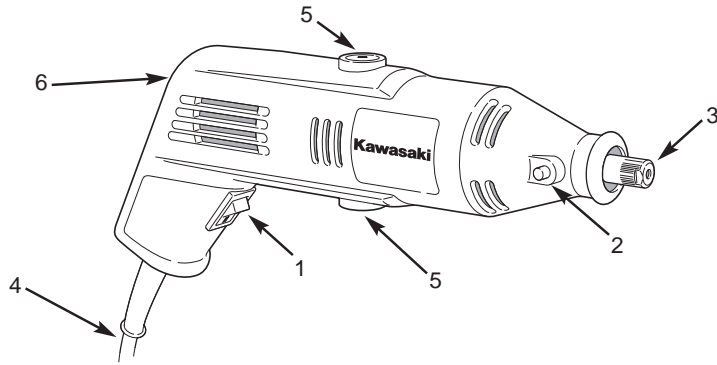

CONTROLS AND COMPONENTS:

- | | |
|-------------------|-----------------------|
| 1. Trigger Switch | 4. Cord |
| 2. Lock-On Button | 5. Brushes |
| 3. Collet | 6. Speed Control Dial |

ASSEMBLY

WARNING Always unplug power tool before changing accessories, changing collets or servicing.

- To loosen collet nut, press the shaft lock button and rotate the shaft by hand until the lock engages the shaft preventing further rotation.
- **DO NOT ENGAGE LOCK WHILE THE ROTARY TOOL IS RUNNING.**
- Never force a larger diameter shank into a collet. Always match the collet nut to the shank size of the accessory you plan to use.
- Avoid excessive tightening of the collet nut when there is no bit inserted.

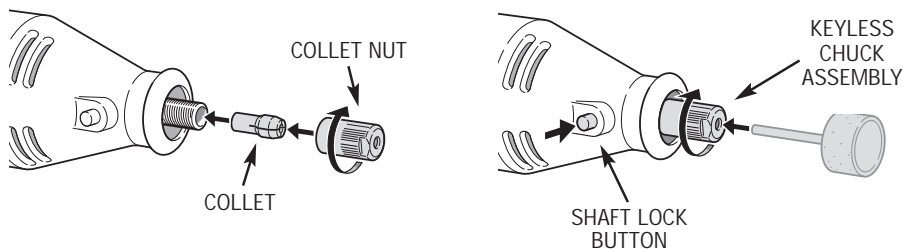

OPERATING INSTRUCTIONS

WARNING Disconnect the power plug from the AC power source before any assembly, adjustments, or adding/removing accessories. Following this preventative step reduces the risk of the saw coming on accidentally and the risk of damage to the workpiece and injury to the operator.

Never hold the tool near your face. Accessories like wire brushes or grinding wheels may come apart during use.

CAUTION Be careful not to cover the air vents with your hand. This will cause the motor to overheat.

This rotary tool is a multipurpose power tool. It is a drill, polisher, power brush, grinder, cutter, and sander all in one. This high-speed, low torque tool is easy to handle and accepts a wide range of accessories from polishers to router bits to wire brushes and grinding wheels. The high speed allows it to do jobs that low speed tools can't handle like engraving glass or cutting hardened steel.

Hold the tool in your hand and find your best grip.

Never push on the tool. The high speed and the accessory, not the pressure on the tool, do the work.

Practice by making passes on a scrap piece of material. This tool works best if you do the work in small increments, moving back and forth until you reach the desired result.

OPERATING SPEEDS

NOTE Speed is affected by voltage changes. If the incoming voltage is reduced, it will slow the RPM of the tool, especially at the lowest setting. If the tool appears to be running slowly, increase the setting accordingly.

The operating speed will vary depending on the material and type of accessory you are using.

To find the right speed for your job, use a test piece of the material. Try various speeds until you find the one that is best for your project.

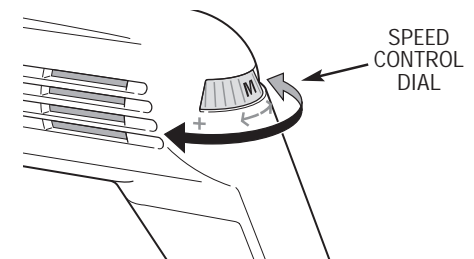

Rotary Tool Speed Settings

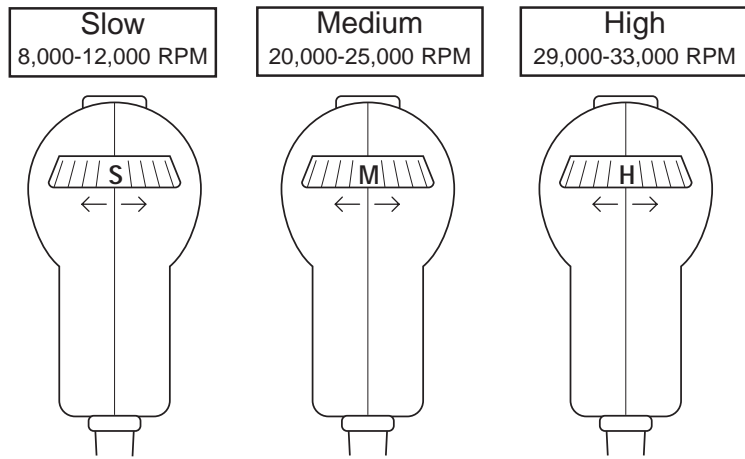

If you are doing delicate woodcarving, polishing, buffing or any use which requires a wire brush, slow speeds of 15,000 RPM or less are best. Any material, like plastic, that melts at low temperatures should also be cut at low speeds.

If you are carving, routing, shaping or cutting glass, metal or hardwoods, higher speeds are necessary. Drilling should also be done at high speed.

Softer metals, like aluminium, copper alloys, and tin may be cut at various speeds, depending on the type of cutting being done. A lubricant like wax should be used on the cutter to keep the cut material from adhering to the cutter teeth.

If the tool is not performing the way you think it should, perhaps you are using the wrong accessory. Putting pressure on the tool will not help the performance.

MAINTENANCE AND CLEANING

⚠ WARNING Always **UNPLUG** the Rotary Tool from the power source before inspecting, performing any maintenance or cleaning.

NOTE This Rotary Tool is lubricated before it leaves the factory. This lubrication should last for the life of the tool. No further lubrication is required.

Use only mild soap and a damp cloth to clean the tool. Never let any liquid get inside the casing. Never immerse any part of the tool in a liquid. Always keep the ventilation openings clear.

Brushes will wear with use and should be inspected periodically by qualified personnel.

Regularly clean the ventilation slots in your tool using only a soft brush or dry cloth.

Never open the Rotary Tool case. Do not attempt to repair the Rotary Tool yourself. Opening the case will void your warranty.

ACCESSORIES

Use only accessories that are recommended by the manufacturer for your model. Accessories that may be suitable for one tool may become hazardous when used on another tool.

Always attach grounded (3-prong) extension cords to grounded (3-hole) outlets.

This product should be grounded. In the event of an electrical short circuit, grounding reduces the risk of electric shock by providing an escape wire for the electric current. This product is equipped with a cord having a grounding wire with an appropriate grounding plug. The plug must be plugged into an outlet that is properly installed and grounded in accordance with all local codes and ordinances.

If you must use an extension cord, be sure that the gauge is large enough to carry the amount of current necessary for your power tool. If not, your tool may experience a loss of power, excessive voltage drop or overheating. The smaller the gauge number, the heavier the cord (see table below).

RECOMMENDED SIZES OF EXTENSION CORDS 120 VOLT AC 60 HZ TOOLS

TOOL CURRENT RATING	CONDUCTOR SIZE IN A.W.G				
	AMPERE	10FT.	25FT.	50FT.	100FT.
3-6		18	18	18	18
6-8		18	18	18	16
8-10		18	18	18	14
10-12		16	16	14	14
12-16		14	12	12	-
16-20		12	12	12	-

INSERTING/REMOVING ACCESSORIES

⚠ WARNING Always unplug rotary tool before changing accessories, changing collets or servicing. The tool could start unexpectedly, causing serious injury.

TO LOOSEN THE COLLET NUT:

1. Press the shaft lock button. Rotate the shaft manually until the lock engages and prevents further rotation.

⚠ CAUTION Do not attempt to engage the shaft lock while the tool is running.

2. If the collet nut has a hexagonal shape, use a wrench to loosen the collet nut by turning in the direction of the arrow labeled L in the illustration. The collet nut must be loose in order to insert or remove accessories.
3. Remove the old accessory (if any) and install the new accessory, being sure to push it as far as possible into the collet.
4. Tighten the collet nut by hand until snug.
5. Finish tightening the collet by turning the wrench in the direction of the arrow labeled T in the illustration. Do not overtighten.

COLLET SIZES

Your rotary tool kit may have multiple collets to accommodate different accessories with varying shank sizes.

TO CHANGE A COLLET:

1. Loosen the collet nut as described above, then remove the collet nut.
2. Remove the old collet.
3. Insert the loose collet.
4. Tighten the collet nut as described above.

Each collet has a series of rings on its shank that identify its size.

- 1/32" – one (1) ring
- 1/16" – two (2) rings
- 3/32" – three (3) rings
- 1/8" – no rings

BALANCING

For best results, be sure to balance each accessory in the collet. Your tool's high RPM makes imbalances easily detectable as a wobble while the tool is running. To balance an accessory:

1. Stop the tool.
2. Loosen the collet nut.
3. Rotate the accessory 1/4 turn.
4. Tighten the collet.
5. Run the tool.
6. Continue adjusting as needed. You will hear and feel when the accessory is properly balanced.

CONNECTING FLEXIBLE SHAFT TO TOOL

FOR MODELS 840168 AND 840169:

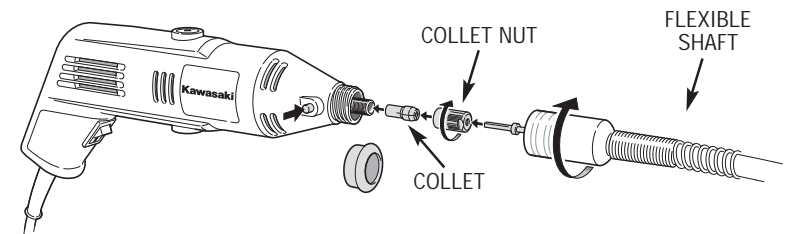

⚠ WARNING

Never bend the flexible shaft with a radius of less than 6" when operating. Please store the flexible shaft in the designated compartment of the tool box when not in use.

Not for use with router bits. Use with router bits with cause kickback.

1. Remove spindle nut and collet nut from the tool by turning them counterclockwise.
2. Remove the collet from motor shaft.
3. Insert flexible shaft inner cable into the motor shaft until the stopper touches the motor shaft.
4. Thread flexible shaft collet nut onto the motor shaft by turning it clockwise. Tighten with collet wrench.
5. Thread flexible shaft nut onto the tool housing by turning it clockwise.

NOTE Only tighten flexible shaft nut finger tight. **DO NOT** use pliers or wrench.

CHANGING COLLET AND ACCESSORIES IN FLEXIBLE SHAFT

To change the collet or install an accessory in the flexible shaft, follow the same general procedure as for changing the collet and for installing accessories on the rotary tool. To lock the spindle, rotate the collet until the hole in the shaft is aligned with the hole in the flexible collar. Insert the L-key through the holes to lock the shaft.

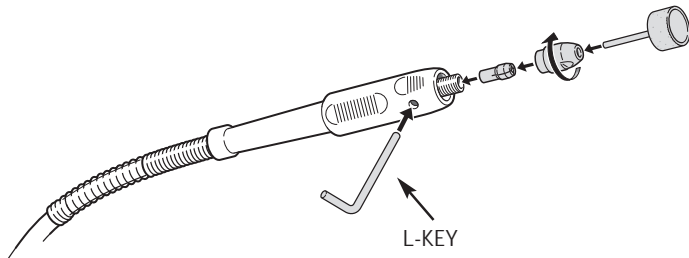

NOTE Do not attempt to loosen or tighten the collet without locking the shaft as noted above. Damage to the flexible shaft with result.

INSTALLING RIGHT ANGLE ATTACHMENT

FOR MODELS 840168 AND 840169:

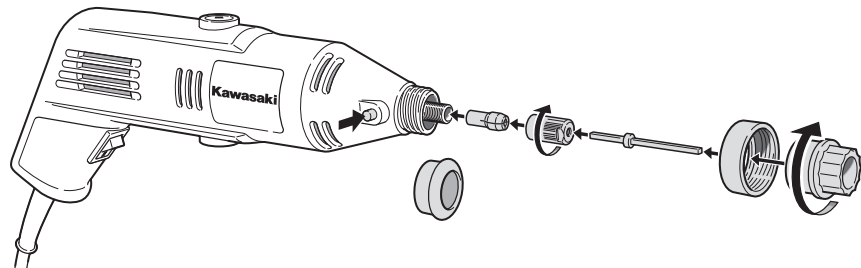

1. Remove spindle nut from the tool by turning it counterclockwise.
2. Remove the collet nut and the collet from the motor shaft.
3. Insert the short end of the drive shaft into the motor shaft until the stopper touched the shaft.

4. Slide the collet nut over the drive shaft and thread it onto the motor shaft by turning the collet nut clockwise. Tighten the collet nut using the collet wrench.
5. Remove the right angle attachment adapter and collar from the right angle attachment by turning the collar counterclockwise.
6. Fasten the angle attachment adapter and collar to the tool by turning the right angle attachment adapter clockwise.

NOTE Only tighten by hand. **DO NOT** use pliers or wrench.

7. Insert the end of the drive shaft into the hole in the right angle attachment.

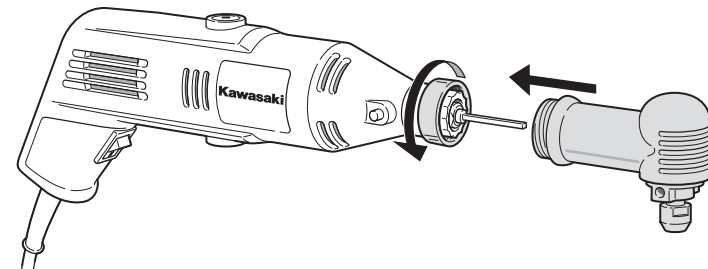

NOTE Rotate the right angle attachment collet nut as you push the right angle attachment onto the adapter until the square end of the drive shaft inserts into the matching square in the right angle attachment.

8. When drive shaft is fully engaged into the right angle attachment, lock the right angle attachment to the adapter by turning the adapter collar clockwise.

NOTE Only tighten by hand. **DO NOT** use pliers or wrench.

To change collet and accessories in the right angle attachment, use the same procedures as outlined for the flexible shaft.

ASSEMBLE ROTARY TOOL STAND

FOR MODEL 840169:

The rotary tool stand is used to hold the rotary tool while using the flexible shaft.

1. Insert the bottom end of the tool holder into the matching slots in the base of the stand.

NOTE Rotate the tool holder to position the tool clamp to the right-hand side.

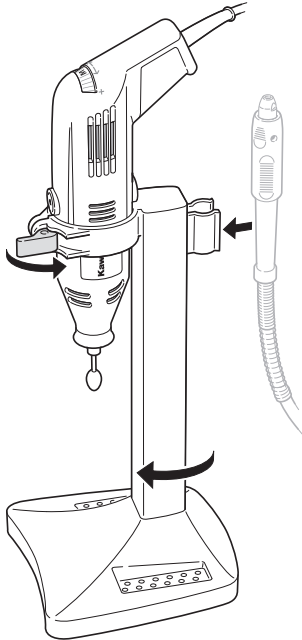

2. Rotate tool holder 90° clockwise to lock it to the base.
3. Pull out on the tool holder clamp lever to open the tool holder clamp.
4. Insert tool into the clamp from the top.

NOTE Make sure the tool is fully inserted to the ridge in the tool body.

5. Push the tool holder clamp lever toward the tool until it snaps into the place and firmly holds the tool in place.

For your convenience, accessories can be stored in the holes provided in the base of the stand.

When the tool is left installed in the stand with the flexible shaft installed, hang the collet end of the flexible shaft in the slotted holder at the rear of the stand.

TYPES OF ACCESSORIES

YOUR ROTARY TOOL MAY BE USED WITH THE FOLLOWING ACCESSORIES:

Sanding Bands: These small drum sanders help you shape and smooth surfaces in tight places. Replace bands when they become worn. Bands come in fine grades for finish and delicate work and coarse grades for heavier work. Sanding bands work best at lower speeds. Experiment with scrap material before working on an actual project. To use a sanding band, loosen the screw in the shank, slip the band onto the shank, then tighten the screw to secure the band.

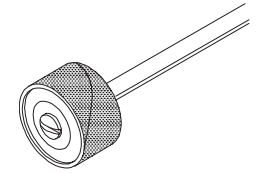

Brushes: Wire brushes are useful for cleaning and polishing metal, while bristle brushes are suitable for cleaning softer surfaces. As with all rotary tool accessories, you should let the speed do the work without applying excessive force. Use the bristle tips only without mashing the brush against the work piece as shown in the top part of the illustration on the right.

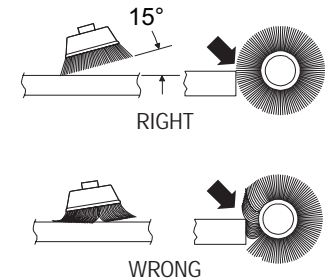

⚠ WARNING NEVER RUN BRUSHES AT SPEEDS ABOVE 15,000 RPM.

The brush could eject bristles at high speed which could become embedded in your skin or which could cause other serious injury.

Drill bits: High-speed steel drill bits are suitable for most drilling applications in wood, plastic, and thin metal. For ceramics, drywall, or other specialized applications, you will need to purchase an appropriate drill bit.



Cutting wheels: To prepare a cutting wheel for use, remove the screw in the center of the shank, mount the wheel, and replace the screw.

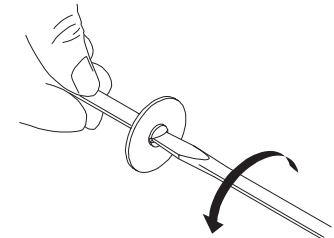

⚠ WARNING Failure to follow all the warnings for using attachments listed in the front of this manual could cause the cutting wheel to fragment, causing serious injury.

Grinding stones: Use these stones for smoothing hard materials such as wood, plastic, and metal. Be sure not to allow the work piece to overheat as this can cause charring (wood), melting (plastic), or discoloration (metal). Aluminum oxide (red) accessories are best for wood, metals, and plastics, while silicon carbide (blue) accessories are best for very hard surfaces such as glass.

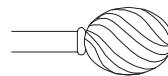

Cutting bits: Use cutting bits for shaping various materials. The smallest cutting bits are suitable for use in engraving.

Polishing wheels: These accessories are useful for removing tarnish and weathering on metal and for polishing plastics. They require a special shank with a screw tip. To prepare a polishing wheel, screw the felt onto the shank tip. Reverse to remove. Polishing grease can be used in small quantities to aid in polishing metal. Lower speeds are best for these accessories.

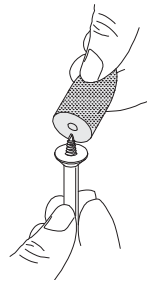

Router bits: An assortment of router bits is available for purchase from your hardware or home center retailer. These accessories carve patterns in wood and plastic that can be used for ornamental purposes or for joining (such as when cutting a dado).

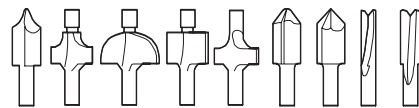

Collets: Collets of various sizes are used to accommodate accessories with different-sized shanks. Refer to the section on Collet Sizes for instructions on changing the collet.



Threaded-tip shanks: Threaded-tip shanks are used for felt polishing wheels. Shanks with a long threaded tip are used for pointed polishing wheels while shanks with short threaded tips are used for round felt polishing wheels. To install a felt polishing wheel, simply screw it onto the threaded shank.

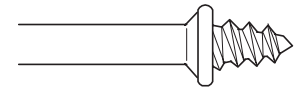

Screw shanks: Screw shanks are used for mounting cutting wheels.

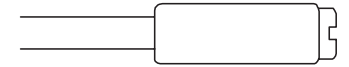

Sanding band shanks: Sanding band shanks feature an expanding core that hold disposable bands securely. To contract the core to remove or install a band, loosen the screw. Tightening the screw expands the core.

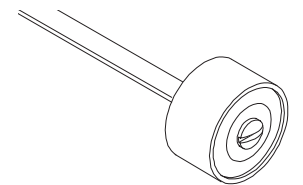

SPECIFICATIONS

SPECIFICATIONS	
Voltage	120V ~ 60 Hz
Rated Current	1 A
No Load Speed	8000-33000 RPM

OTHER CONSUMER DO-IT-YOURSELF (DIY) TOOLS

Alltrade offers a full range of Kawasaki™ tools that make DIY jobs easy. If you would like further information on the following products, please contact Alltrade Customer Service Department at 1-800-590-3723.

- Cordless Drills/Screwdrivers
- Impact Wrenches
- Sanders
- Jigsaws
- Circular Saws
- Angle Grinders
- Reciprocating Saws
- Routers
- Rotary Tools
- Corded and Cordless Multi-Purpose Tools
- Wide Range of Accessories and more

3 YEAR LIMITED WARRANTY

Express and Exclusive Limited Warranty to Original Retail Buyer

Alltrade Tools LLC (hereinafter "Alltrade") expressly warrants to the original retail purchaser of the accompanying KAWASAKI™ power tool and no one else all parts of the product (except those parts referred to below which are specifically excluded from such warranty (see Exclusions)) to be free from defects in materials and workmanship for a period of three years from original date of purchase, except that such warranty with regard to the battery shall be for a period of two years from original date of purchase, unless the tool is used for commercial or rental purposes.

SPECIAL WARRANTY NOTE FOR COMMERCIAL OR RENTAL USE: The above warranty for this Kawasaki™ power tool, including the battery, shall be effective for only 90 days from the original date of purchase if this tool is used for any **COMMERCIAL OR RENTAL PURPOSE.**

The date of purchase shall be the date of shipment to the original purchaser, or the date the original purchaser took possession, custody or control of the product, whichever occurred first. This warranty shall be null and void if the product or any component thereof is modified or altered. This warranty does not apply to any other product and/or component thereof manufactured or distributed by Alltrade, and does not apply to products and/or components thereof designed, manufactured and/or assembled by others, for which Alltrade makes no warranties whatsoever. **THERE ARE NO WARRANTIES WHICH EXTEND BEYOND THE DESCRIPTION ON THE FACE HEREOF.**

Warranty Performance

By purchasing the product, purchaser expressly acknowledges and agrees that their sole and exclusive remedy under this warranty shall be strictly limited to the repair or replacement of any covered nonconforming items or parts thereof provided that any such nonconforming item and/or part is promptly returned to Alltrade's facility postage pre-paid and insured (address: ALLTRADE Warranty Claims & Repair, 1431 Via Plata, Long Beach, CA 90810, Attn: Customer Service 1-800-590-3723) within the applicable warranty period, with a written request by purchaser that Alltrade repair and/or replace the nonconforming item and/or part. We recommend that you keep the original product packaging in the event you need to ship the unit. We suggest the package be insured against loss or in transit damage. When sending your product include your name, address, phone number, dated proof of purchase (or copy), and a statement about the nature of problem. Warranty coverage is conditioned upon purchaser furnishing Alltrade with adequate written proof that they are the original purchaser and of the original purchase date. Parts returned, freight prepaid and insured, to Alltrade's facility (see above address) will be inspected and, at Alltrade's option, repaired and/or replaced free of charge if found to be defective and subject to warranty. Alltrade retains the sole discretion

to determine whether any item or part is nonconforming and, if so, whether the item and/or part will be repaired and/or replaced. If the unit is repaired, new or reconditioned replacement parts may be used. If Alltrade chooses to replace the product, it may replace it with a new or reconditioned one of the same or comparable design. The repaired or replaced unit will be warranted under the terms of the remainder of the warranty period. Typically, a defective product that is returned within the first 30 days after the purchase date will be replaced; for items returned after the first 30 days and within the warranty period, covered defective parts not subject to normal wear and tear or other exclusions will be repaired or replaced, at Alltrade's option. During the warranty period, Alltrade will be responsible for the return shipping charges. Alltrade's repair and/or replacement of any nonconforming item and/or part thereof shall constitute fulfillment of all obligations to the purchaser. Alltrade shall not be responsible or liable for any expense, including freight charges, or repairs made outside Alltrade's facility, unless expressly agreed to by Alltrade in writing. Under no circumstances shall Alltrade bear any responsibility for loss of the unit, loss of time or rental, inconvenience, commercial loss or consequential damages.

Exclusions

This warranty does not cover parts damaged due to normal wear, abnormal conditions, misapplication, misuse, abuse, accidents, operation at other than recommended pressures or temperatures, improper storage or freight damage. Parts damaged or worn by operation in dusty environments are not warranted. Failure to follow recommended operating and maintenance procedures also voids warranty.

This limited warranty does not apply to accessory items such as drill bits, screwdriving bits, circular saw blades, jigsaw blades, grinding wheels, sanding sheets and other related items.

DAMAGE TO THE PRODUCT RESULTING FROM TAMPERING, ACCIDENT, ABUSE, NEGLIGENCE, FAILURE TO FOLLOW INSTRUCTIONS, UNAUTHORIZED REPAIRS OR ALTERATIONS, DAMAGE WHILE IN TRANSIT TO OUR SERVICE FACILITY, USE OF UNAPPROVED OR IMPROPER ATTACHMENTS OR ACCESSORIES, COMMERCIAL AND RENTAL APPLICATIONS OR OTHER CAUSES UNRELATED TO PROBLEMS WITH MATERIAL OR WORKMANSHIP ARE NOT COVERED BY THIS WARRANTY.

Alltrade will not be liable for the following: labor charges, loss or damage resulting from improper operation, maintenance or repairs made by other persons; pre-delivery services such as assembly, oil or lubricants, and adjustment; maintenance services that are normally required to maintain the product.

The use of other than genuine Alltrade Repair Parts will void warranty.

Warranty Disclaimers

EXCLUSION AND DISCLAIMER OF ALL OTHER EXPRESS WARRANTIES, GUARANTIES AND/OR REPRESENTATIONS. EXCEPT FOR THE LIMITED WARRANTY PROVIDED ABOVE, ALL OTHER EXPRESS WARRANTIES, GUARANTIES AND/OR REPRESENTATIONS BY ALLTRADE AND/OR ITS REPRESENTATIVE(S) REGARDING THE DESIGN, MANUFACTURE, PURCHASE, USE AND/OR OPERATION OF THE PRODUCT OR ANY COMPONENT THEREOF SOLD HEREUNDER, REGARDLESS OF WHETHER ANY SUCH WARRANTY, GUARANTY AND/OR REPRESENTATION, WRITTEN OR ORAL, ARISES BY OPERATION OF LAW AND/OR EQUITY AND/OR BY ANY ACT OR OMISSION OF ALLTRADE AND/OR ITS REPRESENTATIVE(S), OR THE BUYER, ARE HEREBY EXPRESSLY EXCLUDED AND DISCLAIMED BY ALLTRADE AND/OR ITS REPRESENTATIVES. PURCHASER KNOWINGLY AND WILLINGLY WAIVES ANY AND ALL SUCH WARRANTIES AND RIGHTS, CLAIMS AND/OR CAUSES OF ACTION ARISING THEREFROM OR BASED THEREON. PURCHASER'S SOLE AND EXCLUSIVE REMEDY IS AS STATED ABOVE.

EXCLUSION AND DISCLAIMER OF ALL IMPLIED WARRANTIES, INCLUDING THE IMPLIED WARRANTIES OF MERCHANTABILITY AND FITNESS FOR A PARTICULAR PURPOSE. NO WARRANTY, ORAL OR WRITTEN, OTHER THAN THE ABOVE WARRANTY IS MADE WITH REGARD TO THIS PRODUCT. ALL EXPRESS AND/OR IMPLIED WARRANTIES, GUARANTIES AND/OR REPRESENTATIONS BY ALLTRADE AND/OR ITS REPRESENTATIVE(S) REGARDING THE DESIGN, MANUFACTURE, PURCHASE, USE AND/OR OPERATION OF THE PRODUCT OR ANY COMPONENT THEREOF SOLD HEREUNDER, REGARDLESS OF WHETHER ANY SUCH WARRANTY, GUARANTY AND/OR REPRESENTATION, WRITTEN OR ORAL, ARISES BY OPERATION OF LAW AND/OR EQUITY AND/OR BY ANY ACT OR OMISSION OF ALLTRADE AND/OR ITS REPRESENTATIVE(S), OR THE PURCHASER, INCLUDING BUT NOT LIMITED TO THE IMPLIED WARRANTY OF MERCHANTABILITY AND THE WARRANTY OF FITNESS FOR A PARTICULAR PURPOSE, ARE HEREBY EXPRESSLY EXCLUDED AND DISCLAIMED BY ALLTRADE AND/OR ITS REPRESENTATIVES. PURCHASER KNOWINGLY AND WILLINGLY WAIVES ANY AND ALL SUCH WARRANTIES AND RIGHTS, CLAIMS AND/OR CAUSES OF ACTION ARISING THEREFROM OR BASED THEREON. PURCHASER'S SOLE AND EXCLUSIVE REMEDY IS AS STATED ABOVE.

Limitation Of Liability

IN NO EVENT SHALL ALLTRADE AND/OR ITS REPRESENTATIVE(S) BE LIABLE FOR INDIRECT, INCIDENTAL, SPECIAL AND/OR CONSEQUENTIAL DAMAGES OF ANY KIND ARISING OUT OF OR RELATED TO, DIRECTLY OR INDIRECTLY, ANY BREACH OF ANY PROVISION OF ANY AGREEMENT BETWEEN ALLTRADE AND/OR ITS REPRESENTATIVE(S) AND PURCHASER, ANY WARRANTY HEREUNDER, AND/OR THE EXISTENCE, DESIGN, MANUFACTURE, PURCHASE, USE AND/OR OPERATION OF ANY ITEM(S) SOLD HEREUNDER EVEN IF ALLTRADE AND/OR ITS REPRESENTATIVE(S) HAS BEEN ADVISED OF THE POSSIBILITY OF ANY SUCH

DAMAGES. IN NO EVENT, WHETHER AS A RESULT OF A BREACH OF CONTRACT, WARRANTY, TORT (INCLUDING NEGLIGENCE) OR OTHERWISE, SHALL ALLTRADE'S AND/OR ITS REPRESENTATIVE(S)' LIABILITY EXCEED THE PRICE OF THE PRODUCT. ANY AND ALL LIABILITY CONNECTED WITH THE USE OF THIS PRODUCT SHALL TERMINATE UPON THE EXPIRATION OF THE WARRANTY PERIODS SPECIFIED ABOVE.

Limitations on Warranty Disclaimers

Some states do not allow limitations on how long an implied warranty lasts and some states do not allow the exclusion or limitation of the incidental or consequential damages, so part or all of the above limitations or exclusions may not apply to you. This warranty gives you specific legal rights, and you may also have other rights which vary from state to state.

If your product is not covered by this warranty, please call our Customer Service Department toll free at 1-800-590-3723 for general repair information and charges.