

Kawasaki™

19.2V BATTERY-OPERATED IMPACT WRENCH

INSTRUCTION MANUAL



BATTERIES AND
CHARGERS
SOLD SEPARATELY

THIS MANUAL CONTAINS IMPORTANT INFORMATION REGARDING SAFETY, OPERATION, MAINTENANCE AND STORAGE OF THIS PRODUCT. BEFORE USE, READ CAREFULLY AND UNDERSTAND ALL CAUTIONS, WARNINGS, INSTRUCTIONS AND PRODUCT LABELS. FAILURE TO DO SO COULD RESULT IN SERIOUS PERSONAL INJURY AND/OR PROPERTY DAMAGE.

IF YOU SHOULD HAVE ANY QUESTIONS OR EXPERIENCE A PROBLEM WITH YOUR ALLTRADE PRODUCT, DO NOT RETURN THIS PRODUCT TO THE STORE. PLEASE CALL OUR CUSTOMER SERVICE DEPARTMENT AT 1-800-590-3723. BEFORE YOU CALL, HAVE THE FOLLOWING INFORMATION AVAILABLE: MODEL No., DATE PURCHASED AND STORE LOCATION. AN ALLTRADE REPRESENTATIVE CAN RESOLVE YOUR PROBLEM OVER THE PHONE. IF YOU WOULD LIKE TO MAKE A SUGGESTION OR COMMENT, GIVE US A CALL OR EMAIL US AT: INFO@ALLTRADETOOLS.COM. YOUR FEEDBACK IS VITAL TO US.



KAWASAKI™ IS A TRADEMARK LICENSED BY KAWASAKI™ MOTORS CORP., U.S.A., WHICH DOES NOT MANUFACTURE OR DISTRIBUTE THIS PRODUCT. CONSUMER INQUIRES SHOULD BE DIRECTED TO:

©COPYRIGHT 2007 ALLTRADE TOOLS, LLC.
1431 VIA PLATA
LONG BEACH, CA 90810-1842 USA
840458 --19.2V Cordless Impact Wrench_Rev 6/21/07

FOR CUSTOMER SERVICE
POUR LE SERVICE APRÈS VENTE
OU DU CONSOMMATEUR
PARA EL SERVICIO
PARA EL CONSUMIDOR
1-800-590-3723

Printed in China

TABLE OF CONTENTS

CONGRATULATIONS! 2
INTENDED USE 2
SECTION ONE
GENERAL SAFETY RULES—FOR ALL BATTERY OPERATED TOOLS ... 2
RECOGNIZE SAFETY SYMBOLS, WORDS AND LABELS 2-3
IMPORTANT SAFEGUARDS 3
WORK AREA 4
ELECTRICAL SAFETY 4
PERSONAL SAFETY 5
TOOL USE AND CARE 5-6
SERVICE 6
SECTION TWO
SPECIFIC SAFETY RULES AND/OR SYMBOLS 6
SAFETY RULES FOR IMPACT WRENCHES 6-7
SYMBOLS 8
SECTION THREE
FUNCTIONAL DESCRIPTION 9
BATTERY 9-13
REMOVING / ATTACHING BATTERY PACK 11
CHARGER #690072 / ADAPTER #690074 11
CHARGING BATTERY PACK USING
CHARGER #690072 / ADAPTER #690074 12
ONE HOUR CHARGER #690507 12-13
CHARGING BATTERY PACK USING ONE HOUR
CHARGER #690507 13
ASSEMBLY 13-14
INSTALLING / REMOVING SOCKET ON THE ANVIL 14
OPERATING THE IMPACT WRENCH 14-15
VARIABLE SPEED TRIGGER SWITCH 14
FORWARD / REVERSE AND TRIGGER LOCK LEVER 15
SECTION FOUR
MAINTENANCE AND CLEANING 15
ACCESSORIES 16
SPECIFICATIONS 16
PROTECTING THE ENVIRONMENT 16

OTHER CONSUMER DO-IT-YOURSELF (DIY) TOOLS 17

SECTION FIVE

2 YEAR LIMITED WARRANTY 17-20

CONGRATULATIONS!

Thanks for choosing this product. At Alltrade, our aim is to provide you with quality products at an affordable price, and we want you to be totally satisfied with your product and our Customer Service. If any help or advice is needed, please contact us at 1-800-590-3723. Properly cared for, this tool will give you many years of satisfaction.

INTENDED USE

This tool is intended for consumer use only. Your charger and/or adapter has been designed for charging batteries of the type approved and supplied with this tool.

GENERAL SAFETY RULES—FOR ALL BATTERY OPERATED TOOLS

⚠ WARNING **READ AND UNDERSTAND ALL INSTRUCTIONS.** Failure to follow all instructions listed below may result in electric shock, fire and/or serious personal injury.

SAVE THESE INSTRUCTIONS FOR FUTURE REFERENCE.

RECOGNIZE SAFETY SYMBOLS, WORDS AND LABELS

The safety instructions provided in this manual are not intended to cover all possible conditions and practices that may occur when operating, maintaining and cleaning power tools.

Always use common sense and pay particular attention to all the **DANGER**, **WARNING**, **CAUTION** and **NOTE** statements of this manual.



This is the safety alert symbol. It is used to alert you to potential personal injury hazards. Obey all safety messages that follow this symbol to avoid possible injury or death.



DANGER indicates an imminently hazardous situation which, if not avoided, will result in death or serious injury.

⚠ WARNING

WARNING indicates a potentially hazardous situation which, if not avoided, could result in death or serious injury.

⚠ CAUTION

CAUTION indicates a potentially hazardous situation which, if not avoided, may result in minor or moderate injury.

CAUTION

CAUTION used without the safety alert symbol indicates a potentially hazardous situation which, if not avoided, may result in property damage.

NOTE

NOTE provides additional information that is useful for proper use and maintenance of this tool. If a NOTE is indicated make sure it is fully understood.

IMPORTANT SAFEGUARDS

⚠ DANGER

People with electronic devices, such as pacemakers, should consult their physician(s) before using this product. Operation of electrical equipment in close proximity to a heart pacemaker could cause interference or failure of the pacemaker.

WARNING: Some dust created by power sanding, sawing, grinding, drilling and other construction activities contains chemicals known to the State of California to cause cancer, birth defects or other reproductive harm.

Some examples of these chemicals are:

- Lead from lead-based paints.
- Crystalline silica from bricks and cement and other masonry products, and arsenic and chromium from chemically-treated lumber.

Your risk from these exposures varies, depending on how often you do this type of work. To reduce your exposure to these chemicals: work in a well ventilated area, and work with approved safety equipment, such as dust masks that are specially designed to filter out microscopic particles.

WARNING: Handling the power cord on this product may expose you to lead, a chemical known to the State of California to cause cancer and birth defects or other reproductive harm. *Wash hands after handling.*

WORK AREA

⚠ WARNING

Keep your work area clean and well lit. Cluttered benches and dark areas invite accidents.

Do not operate power tools in explosive atmospheres, such as in the presence of flammable liquids, gases or dust. Power tools create sparks which may ignite the dust or fumes.

Keep bystanders, children, and visitors away while operating a power tool. Distractions can cause you to lose control.

ELECTRICAL SAFETY

⚠ WARNING

Do not abuse the cord. Never use the cord to carry the tool. Keep the cord away from heat, oil, sharp edges, or moving parts. Replace damaged cords immediately. Damaged cords may create a fire.

A battery operated tool with integral batteries or a separate battery pack must be recharged only with the specified charger for the battery. A charger that may be suitable for one type of battery may create a risk of fire when used with another battery.

Use battery operated tool only with specifically designated battery pack. Use of any other batteries may create risk of fire.

PERSONAL SAFETY

⚠ WARNING

Stay alert, watch what you are doing, and use common sense when operating a power tool. Do not use tool while tired or under the influence of drugs, alcohol or medication. A moment of inattention while operating power tools may result in serious personal injury.

Dress properly. Do not wear loose clothing or jewelry. Contain long hair. Keep your hair, clothing, and gloves away from moving parts. Loose clothes, jewelry or long hair can be caught in moving parts.

Avoid accidental starting. Be sure switch is in the locked or "OFF" position before inserting battery pack. Carrying power tools with your finger on the switch or inserting battery pack into a tool with the power switch "ON" invites accidents.

Remove adjusting keys or wrenches before turning the tool "ON". A wrench or a key that is left attached to a rotating part of the tool may result in personal injury.

Do not overreach. Keep proper footing and balance at all times. Proper footing and balance enable better control of the tool in unexpected situations.

Use safety equipment. Always wear eye protection. Dust mask, non-skid safety shoes, hard hat, or hearing protection must be used for appropriate conditions.

TOOL USE AND CARE

⚠ CAUTION

Use clamps or other practical ways to secure and support the workpiece to a stable platform. Holding the work by hand or against your body is unstable and may lead to loss of control.

Do not force tool. Use the correct tool for your application. The correct tool will do the job better and safer at the rate for which it is designed.

Do not use the tool if the power switch does not turn it "ON" or "OFF". A tool that cannot be controlled with the switch is dangerous and must be repaired.

Disconnect battery pack from tool or place the switch in the locked or "OFF" position before making any adjustments, changing accessories, or storing the tool. Such preventative safety measures reduce the risk of starting the tool accidentally.

Store idle tools out of reach of children and other untrained persons. Tools are dangerous in the hands of untrained users.

⚠ CAUTION

When battery pack is not in use, keep it away from other metal objects like: paper clips, coins, keys, nails, screws, or other small metal objects that can make a connection from one terminal to another. Shorting the battery terminals together may cause sparks, burns or a fire.

Maintain tools with care. Keep cutting tools sharp and clean. Properly maintained tools with sharp cutting edge are less likely to bind and are easier to control.

Check for misalignment or binding of moving parts, breakage of parts, and any other condition that may affect the tool's operation. If damaged, have the tool serviced before using. Many accidents are caused by poorly maintained tools.

Use only accessories that are recommended by the manufacturer for your model. Accessories that may be suitable for one tool may create a risk of injury when used on another tool.

SERVICE

⚠ CAUTION

Tool service must be performed only by qualified repair personnel. Service or maintenance by unqualified personnel may result in a risk of injury.

When servicing a tool, use only identical replacement parts. Follow instructions in the Maintenance section of this manual. Use of unauthorized parts or failure to follow Maintenance Instructions may create a risk of shock or injury.

SPECIFIC SAFETY RULES AND / OR SYMBOLS

⚠ CAUTION

Hold tool by insulated gripping surfaces when performing an operation where the cutting tool may contact hidden wiring. Contact with a "live" wire will also make exposed metal parts of the tool "live" and shock the operator.

SAFETY RULES FOR IMPACT WRENCHES

⚠ CAUTION

Always wear safety goggles or eye protection when using this tool. Use a dust mask or respirator for applications which generate dust.

Do not grasp the tool or place your hands too close to the spinning chuck or drill bit. Your hand may be lacerated or may cause injury.

CAUTION

Secure the material being worked on. Never hold it in your hand or across your legs. Unstable support can cause loss of control and injury.

Position yourself to avoid being caught between the tool or side handle and walls or posts. Should the socket or bit become bound in the work, the reaction torque of the tool could crush your hand or leg.

Check to see that keys and adjusting wrenches are removed from the Cordless Impact Wrench before switching the tool "ON". Keys or wrenches can fly away at high velocity striking you or a bystander.

When using the Cordless Impact Wrench, always maintain a firm grip on the tool with both hands.

Hold tool by insulated gripping surfaces when performing an operation where the cutting tool may contact hidden wiring. Contact with a "live" wire will also make exposed metal parts of the tool "live" and shock the operator.

Keep the handle of the Cordless Impact Wrench dry, clean, and free from oil and grease.

Do not run the Cordless Impact Wrench while carrying it at your side. A spinning socket or bit could become entangled with clothing and injury may result.





Disconnect the plug or remove the battery pack from tool and place the switch in the locked or "OFF" position before making any assembly adjustments, changing accessories, performing any inspection, maintenance or cleaning procedures. Such preventive safety measures reduce the risk of starting the tool accidentally.

Do not use the Cordless Impact Wrench if it has been damaged, left outdoors in the rain, snow, wet or damp environments, or immersed in liquid.

Maintain labels and nameplates on the Cordless Impact Wrench. These carry important information. If unreadable or missing, contact Alltrade for a replacement.

SYMBOLS

IMPORTANT: Some of the following symbols may be used on your tool. Please study them and learn their meaning. Proper interpretation of these symbols will allow you to operate the tool better and safer.

SYMBOL	NAME	EXPLANATION
V	Volts	Voltage (Potential)
A	Amperes	Current
Hz	Hertz	Frequency (Cycles per Second)
W	Watt	Power
Kg	Kilograms	Weight
	Alternating Current	Type of Current
	Direct Current	Type of Current
	Alternating or Direct Current	Type of Current
	Earthing Terminal	Grounding Terminal
	Class II Construction	Denotes Double Insulation
min	Minutes	Time
s	Seconds	Time
φ	Diameter	Size of Drill Bits, Grinding Wheels, etc.
n_0	No load speed	No-load Rotational Speed
.../min	Revolutions per Minute	Revolutions, Surface Speed, Strokes, etc. per Minute
1,2,3, ...	Ring Selector Settings	Speed, Torque or Position Settings

FUNCTIONAL DESCRIPTION

CONTROLS AND COMPONENTS:

1. Variable Speed Trigger Switch
2. Forward/Reverse and Trigger Lock Lever
3. Gear Enclosure
4. Anvil
5. Comfort Rubber Grip

ACCESSORIES:

6. 1/2" Drive Impact Socket (4)
7. 3/8" Adapter

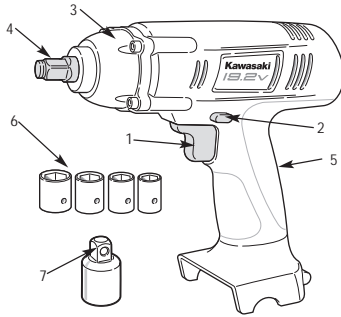

BATTERY

⚠ WARNING

Before using battery pack, please read carefully all instructions and cautionary markings on battery pack, battery charger and product using battery.

Do not incinerate the battery pack even if it is severely damaged or is completely worn out. The battery pack can explode.

Do not carry battery packs in aprons, pockets, or tool boxes, product kit boxes, drawers, etc. with loose metal objects. Battery pack terminals could be short circuited causing damage to the battery pack, severe burns or fire.

The battery pack is Nickel-Cadmium (Ni-Cad) and is considered to be a toxic material by the Environmental Protection Agency. Before disposing of damaged or worn out Ni-Cad battery packs, check with your State Environmental Protection Agency to find out about special restrictions on the disposal of these battery packs, take them to your local recycling center for proper disposal, or call 1-800-822-8837.

9

⚠ WARNING

Use only Kawasaki™ 19.2V Battery Pack #691034 or #691240 with the One Hour Charger #690507 or Charger #690072/ Adapter #690074.

NOTE

The battery is not fully charged.

Charger #690072/ Adapter #690074 - Before first use, the battery pack requires 8-10 hours charge time to be fully charged. Subsequent recharging needs 3-5 hours for the battery to be fully charged.

One Hour Charger #690507 - Before first use, the battery pack requires 3-5 hours charge time to be fully charged. Subsequent recharging needs 1 hour for the battery to be fully charged.

Always switch to a fresh battery when tool performance begins to diminish. Severe heat is most destructive to a battery; the more heat generated, the faster the battery loses power. A battery that gets too hot can have a shortened life.

Never over-discharge a battery by using the tool even after tool performance has decreased. Do not attempt to discharge a tool's battery by continuing to pull on the tool trigger. When tool performance begins to diminish, stop the tool and recharge the battery for optimal performance.

Charge battery pack at ambient temperatures between 50° F – 104° F.

Store tool and battery pack in locations where temperatures will not exceed 120°F. This is important to prevent serious damage to the battery cells.

The battery pack should always be recharged when the Cordless Impact Wrench begins to run slowly.

When battery pack is not in use, keep it away from other metal objects such as paper clips, coins, keys, nails, screws or other small metal objects that can make a connection from one terminal to another. Shorting the battery terminals together may cause sparks, burns, or fire.

10

REMOVING / ATTACHING BATTERY PACK

REMOVE BATTERY PACK:

1. Press both release buttons on either side of the Impact Wrench to release the battery pack.
2. Pull battery pack free of Impact Wrench.

ATTACH BATTERY PACK:

1. Align the raised portion of the battery pack with the groove in the battery compartment of the Impact Wrench.
2. Press the battery pack into place. Make sure the latches are securely fastened. Do not use the Impact Wrench if the battery pack is not seated properly.

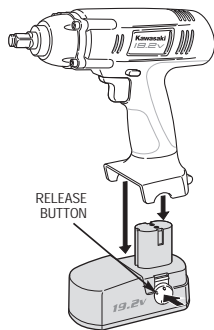

CHARGER #690072 / ADAPTER #690074

WARNING Before using battery charger, please read carefully all instructions and cautionary markings on battery charger, battery pack and product using battery.

NOTE The charger will not automatically turn "OFF" when the battery pack is fully charged. The charging indicator light will remain "ON" until the charger is disconnected from the electrical outlet.

Use only the charger which accompanied your product or direct replacement as listed in this manual. Do not substitute any other charger. Use only Alltrade approved chargers with your product.

Do not disassemble charger.

Do not use charger if it has been damaged, left outdoors in the rain, snow, wet or damp environments, or immersed in liquid.

The battery pack and charger heat during charging. Place the charger on a flat, non-flammable surface away from flammable materials with at least four inches of clearance to allow proper air circulation around the charger and battery pack.

When the battery pack requires recharging, a 3-5 hour charge allows the tool to operate at full power. A charging indicator light on the charger will illuminate to show that charging is taking place.

CHARGING BATTERY PACK USING CHARGER #690072 / ADAPTER #690074

CHARGE BATTERY PACK:

1. Make sure the trigger on the Cordless Impact Wrench is in the "OFF" position and remove the battery pack from the Impact Wrench.
2. Insert the battery pack into the charger. Be sure that the battery pack is fully seated in the charger. Do not force.
3. Plug the charger into the nearest 120 volt, electrical outlet. The indicator light will come "ON".

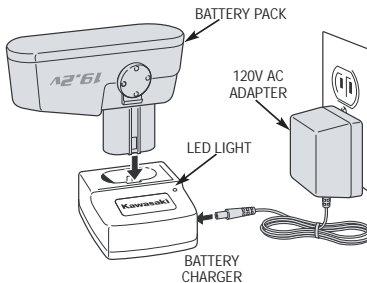

IMPORTANT INFORMATION FOR RECHARGING HOT BATTERIES

When using your Cordless Impact Wrench continuously, the batteries in your battery pack will become hot. You should let a hot battery pack cool down for approximately 30 minutes before attempting to recharge. When the battery pack becomes discharged and is hot, the red light on the charger will flash. When the battery pack cools down, the red light will glow continuously.

NOTE This will occur when continuous use of your Cordless Impact Wrench causes the battery pack to become hot. It does not occur under normal circumstances.

ONE HOUR CHARGER #690507

WARNING Before using battery charger, please read carefully all instructions and cautionary markings on battery charger, battery pack and product using battery.

Use only the charger which accompanied your product or direct replacement as listed in this manual. Do not substitute any other charger. Use only Alltrade approved chargers with your product.

Do not disassemble charger.

Do not use charger if it has been damaged, left outdoors in the rain, snow, wet or damp environments, or immersed in liquid.

The battery pack and charger heat during charging. Place the charger on a flat, non-flammable surface away from flammable materials with at least four inches of clearance to allow proper air circulation around the charger and battery pack.

When the battery pack requires recharging, a 1 hour charge allows the tool to operate at full power. A charging indicator light on the charger will illuminate to show that charging is taking place.

CHARGING BATTERY PACK USING ONE HOUR CHARGER #690507

CHARGE BATTERY PACK:

1. Plug the charger into the nearest 120 volt electrical outlet. The step of the battery has positive and negative terminal markings on it. Align the markings with the identical markings on the top of the charger base. Insert the battery pack into base. Pack will not insert properly if reversed.
2. Make sure the trigger on the Impact Wrench is in the **"OFF"** position and remove the battery pack from the Cordless Impact Wrench.
3. If, when first inserting the battery pack, the red **"ON"** button does not light up, press the **"SET"** button on the charger. When the battery is charging, the red light is **"ON"**.
4. After approximately one hour of charging, the red indicator light should go **"OFF"** and the green light should come **"ON"**. The green light indicates that the battery is fully charged.
5. When fully charged, reattach battery pack onto Cordless Impact Wrench, making certain latches fasten securely. Cordless Impact Wrench will not operate properly if the battery pack is not seated properly.

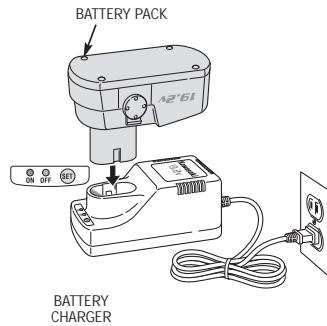

ASSEMBLY

⚠ WARNING Be aware that this tool is always in an operating condition because it does not have to be plugged into an electrical outlet. Always turn the switch **"OFF"** and remove the battery pack before changing bits.

13

INSTALLING / REMOVING SOCKET ON THE ANVIL

⚠ CAUTION When removing the socket or bit from the tool, avoid contact with skin and use proper protective gloves when grasping the socket, bit or accessory. Accessories may be hot after prolonged use.

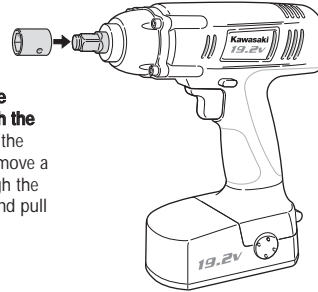

When installing a socket, align the holes in the side of the socket with the dent pin. Press the socket on until the dent pin engages in the hole. To remove a socket, depress the dent pin through the hole using a small pointed object and pull the socket off.

OPERATING THE IMPACT WRENCH

⚠ WARNING Never tape the trigger switch down to provide continuous high speed. The tool may fail under such conditions causing fire or personal injury.

VARIABLE SPEED TRIGGER SWITCH

THIS TOOL IS CONTROLLED BY A TRIGGER SWITCH:

- The speed of the Cordless Impact Wrench depends on the amount of pressure you put on the trigger.
- The more pressure you apply, the faster the Cordless Impact Wrench will go.
- Release the pressure and the Cordless Impact Wrench will slow down.

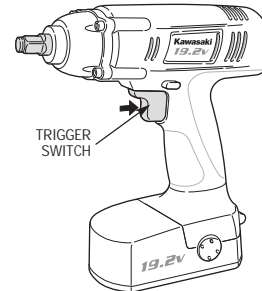

14

FORWARD / REVERSE AND TRIGGER LOCK LEVER

NOTE

- Be sure the trigger is released when changing the position of the lever. Always store the tool in the "LOCKED/OFF" position.
- Always check the direction of the Cordless Impact Wrench's rotation before use.

TO SELECT THE DIRECTIONS OF ROTATION:

- To select forward Cordless Impact Wrench rotation, press the trigger lock from left to right flat against the Cordless Impact Wrench body.
- To select reverse, press the trigger lock lever in the opposite direction.
- The center position locks the tool.

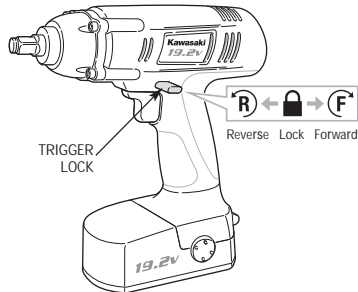

MAINTENANCE AND CLEANING

WARNING Always remove the battery pack before attempting cleaning or maintenance.

NOTE This Cordless Impact Wrench is lubricated before it leaves the factory. This lubrication should last for the life of the tool. No further lubrication is required.

Use only mild soap and a damp cloth to clean the tool. Never let any liquid get inside the casing. Never immerse any part of the tool in a liquid. Always keep the ventilation openings clear.

Always clean the battery pack using only a dry cloth. Do not use liquids.

Always unplug the charger before cleaning it.

Regularly clean the ventilation slots in your tool and charger using only a soft brush or dry cloth.

Never open the Cordless Impact Wrench case, battery pack or charger. Do not attempt to repair the Cordless Impact Wrench, battery pack or charger yourself. Opening any of these parts will void your warranty.

ACCESSORIES

Use only accessories that are recommended by the manufacturer for your model. Accessories that may be suitable for one tool may become hazardous when used on another tool.

Always attach grounded (3-prong) extension cords to grounded (3-hole) outlets.

If you must use an extension cord, be sure that the gauge is large enough to carry the amount of current necessary for your power tool. If not, your tool may experience a loss of power, excessive voltage drop or overheating. The smaller the gauge number, the heavier the cord (see table below).

RECOMMENDED SIZES OF EXTENSION CORDS 120 VOLT AC 60 HZ TOOLS

TOOL CURRENT RATING	CONDUCTOR SIZE IN A.W.G				
	AMPERE	10FT.	25FT.	50FT.	100FT.
3-6	18	18	18	18	18
6-8	18	18	18	18	16
8-10	18	18	18	14	14
10-12	16	16	14	14	14
12-16	14	12	12	-	-
16-20	12	12	12	-	-

SPECIFICATIONS

SPECIFICATIONS	
Voltage	19.2V ----
Speed	0-2000 RPM (no load)
Impacts Per Minute	0-4000 BPM
Maximum Torque	180 ft.lbs.
Battery Type	Ni-Cad

PROTECTING THE ENVIRONMENT

BATTERIES

Alltrade batteries can be recharged many times. At the end of their useful life, recycle batteries with due care for our environment.

Ni-Cad and Ni-MH batteries are recyclable. Take them to your local recycling center or call **1-800-822-8837**. Collected batteries will be recycled or disposed of properly.

OTHER CONSUMER DO-IT-YOURSELF (DIY) TOOLS

Alltrade offers a full range of Kawasaki™ tools that make DIY jobs easy. If you would like further information on the following products, please contact Alltrade Customer Service Department at 1-800-590-3723.

Cordless Drills/Screwdrivers	Reciprocating Saws
Impact Wrenches	Routers
Sanders	Rotary Tools
Jigsaws	Corded and Cordless Multi-Purpose Tools
Circular Saws	Wide Range of Accessories and more
Angle Grinders	

2 YEAR LIMITED HOME USE WARRANTY

Express and Exclusive Limited Home Use Warranty to Original Retail Buyer

Alltrade Tools LLC (hereinafter "Alltrade") expressly warrants to the original retail purchaser of the accompanying KAWASAKI™ portable power tool and no one else all parts of the product (except those parts referred to below which are specifically excluded from such warranty (see Exclusions)) to be free from defects in materials and workmanship for a period of two years from original date of purchase.

SPECIAL WARRANTY NOTE TO CONTRACTORS AND COMMERCIAL USERS: This Kawasaki™ portable power tool is offered as a home use tool and carries a **HOME USE WARRANTY**. This tool is made for home use in the execution of projects and repairs in and around the home. Use of the tool for **COMMERCIAL PURPOSES OR ON A JOBSITE** is not covered under this warranty.

The date of purchase shall be the date of shipment to the original purchaser, or the date the original purchaser took possession, custody or control of the product, whichever occurred first. This warranty shall be null and void if the product or any component thereof is modified, altered or used for any commercial purpose or on a jobsite. This warranty does not apply to any other product and/or component thereof manufactured or distributed by Alltrade, and does not apply to products and/or components thereof designed, manufactured and/or assembled by others, for which Alltrade makes no warranties whatsoever. **THERE ARE NO WARRANTIES WHICH EXTEND BEYOND THE DESCRIPTION ON THE FACE HEREOF.**

Warranty Performance

By purchasing the product, purchaser expressly acknowledges and agrees that their sole and exclusive remedy under this warranty shall be strictly limited to the repair or replacement of any covered nonconforming items or parts thereof provided that any such nonconforming item and/or part is promptly returned to Alltrade's facility

postage pre-paid and insured (address: ALLTRADE Warranty Claims & Repair, 1431 Via Plata, Long Beach, CA 90810, Attn: Customer Service 1-800-590-3723) within the applicable warranty period, with a written request by purchaser that Alltrade repair and/or replace the nonconforming item and/or part. We recommend that you keep the original product packaging in the event you need to ship the unit. We suggest the package be insured against loss or in transit damage. When sending your product include your name, address, phone number, dated proof of purchase (or copy), and a statement about the nature of problem. Warranty coverage is conditioned upon purchaser furnishing Alltrade with adequate written proof that they are the original purchaser and of the original purchase date. Parts returned, freight prepaid and insured, to Alltrade's facility (see above address) will be inspected and, at Alltrade's option, repaired and/or replaced free of charge if found to be defective and subject to warranty. Alltrade retains the sole discretion to determine whether any item or part is nonconforming and, if so, whether the item and/or part will be repaired and/or replaced. If the unit is repaired, new or reconditioned replacement parts may be used. If Alltrade chooses to replace the product, it may replace it with a new or reconditioned one of the same or comparable design. The repaired or replaced unit will be warranted under the terms of the remainder of the warranty period. Typically, a defective product that is returned within the first 30 days after the purchase date will be replaced; for items returned after the first 30 days and within the warranty period, covered defective parts not subject to normal wear and tear or other exclusions will be repaired or replaced, at Alltrade's option. During the warranty period, Alltrade will be responsible for the return shipping charges. Alltrade's repair and/or replacement of any nonconforming item and/or part thereof shall constitute fulfillment of all obligations to the purchaser. Alltrade shall not be responsible or liable for any expense, including freight charges, or repairs made outside Alltrade's facility, unless expressly agreed to by Alltrade in writing. Under no circumstances shall Alltrade bear any responsibility for loss of the unit, loss of time or rental, inconvenience, commercial loss or consequential damages.

Exclusions

This warranty does not cover parts damaged due to normal wear, abnormal conditions, misapplication, misuse, abuse, accidents, operation at other than recommended pressures or temperatures, improper storage or freight damage. Parts damaged or worn by operation in dusty environments are not warranted. Failure to follow recommended operating and maintenance procedures also voids warranty.

This limited warranty does not apply to accessory items such as drill bits, screwdriving bits, circular saw blades, jigsaw blades, grinding wheels, sanding sheets and other related items.

DAMAGE TO THE PRODUCT RESULTING FROM TAMPERING, ACCIDENT, ABUSE, NEGLIGENCE, FAILURE TO FOLLOW INSTRUCTIONS, UNAUTHORIZED REPAIRS OR ALTERATIONS, DAMAGE WHILE IN TRANSIT TO OUR SERVICE FACILITY, USE OF UNAPPROVED OR IMPROPER ATTACHMENTS OR ACCESSORIES, COMMERCIAL AND RENTAL APPLICATIONS OR OTHER CAUSES UNRELATED TO PROBLEMS WITH MATERIAL OR WORKMANSHIP ARE NOT COVERED BY THIS WARRANTY.

Alltrade will not be liable for the following: labor charges, loss or damage resulting from improper operation, maintenance or repairs made by other persons; pre-delivery services such as assembly, oil or lubricants, and adjustment; maintenance services that are normally required to maintain the product.

The use of other than genuine Alltrade Repair Parts will void warranty.

Warranty Disclaimers

EXCLUSION AND DISCLAIMER OF ALL OTHER EXPRESS WARRANTIES, GUARANTIES AND/OR REPRESENTATIONS. EXCEPT FOR THE LIMITED WARRANTY PROVIDED ABOVE, ALL OTHER EXPRESS WARRANTIES, GUARANTIES AND/OR REPRESENTATIONS BY ALLTRADE AND/OR ITS REPRESENTATIVE(S) REGARDING THE DESIGN, MANUFACTURE, PURCHASE, USE AND/OR OPERATION OF THE PRODUCT OR ANY COMPONENT THEREOF SOLD HEREUNDER, REGARDLESS OF WHETHER ANY SUCH WARRANTY, GUARANTY AND/OR REPRESENTATION, WRITTEN OR ORAL, ARISES BY OPERATION OF LAW AND/OR EQUITY AND/OR BY ANY ACT OR OMISSION OF ALLTRADE AND/OR ITS REPRESENTATIVE(S), OR THE BUYER, ARE HEREBY EXPRESSLY EXCLUDED AND DISCLAIMED BY ALLTRADE AND/OR ITS REPRESENTATIVES. PURCHASER KNOWINGLY AND WILLINGLY WAIVES ANY AND ALL SUCH WARRANTIES AND RIGHTS, CLAIMS AND/OR CAUSES OF ACTION ARISING THEREFROM OR BASED THEREON. PURCHASER'S SOLE AND EXCLUSIVE REMEDY IS AS STATED ABOVE.

EXCLUSION AND DISCLAIMER OF ALL IMPLIED WARRANTIES, INCLUDING THE IMPLIED WARRANTIES OF MERCHANTABILITY AND FITNESS FOR A PARTICULAR PURPOSE. NO WARRANTY, ORAL OR WRITTEN, OTHER THAN THE ABOVE WARRANTY IS MADE WITH REGARD TO THIS PRODUCT. ALL EXPRESS AND/OR IMPLIED WARRANTIES, GUARANTIES AND/OR REPRESENTATIONS BY ALLTRADE AND/OR ITS REPRESENTATIVE(S) REGARDING THE DESIGN, MANUFACTURE, PURCHASE, USE AND/OR OPERATION OF THE PRODUCT OR ANY COMPONENT THEREOF SOLD HEREUNDER, REGARDLESS OF WHETHER ANY SUCH WARRANTY, GUARANTY AND/OR REPRESENTATION, WRITTEN OR ORAL, ARISES BY OPERATION OF LAW AND/OR EQUITY AND/OR BY ANY ACT OR OMISSION OF ALLTRADE AND/OR ITS REPRESENTATIVE(S), OR THE PURCHASER, INCLUDING BUT NOT LIMITED TO THE IMPLIED WARRANTY OF MERCHANTABILITY AND THE WARRANTY OF FITNESS FOR A PARTICULAR PURPOSE, ARE HEREBY EXPRESSLY EXCLUDED AND DISCLAIMED BY ALLTRADE AND/OR ITS REPRESENTATIVES.

PURCHASER KNOWINGLY AND WILLINGLY WAIVES ANY AND ALL SUCH WARRANTIES AND RIGHTS, CLAIMS AND/OR CAUSES OF ACTION ARISING THEREFROM OR BASED THEREON. PURCHASER'S SOLE AND EXCLUSIVE REMEDY IS AS STATED ABOVE.

Limitation Of Liability

IN NO EVENT SHALL ALLTRADE AND/OR ITS REPRESENTATIVE(S) BE LIABLE FOR INDIRECT, INCIDENTAL, SPECIAL AND/OR CONSEQUENTIAL DAMAGES OF ANY KIND ARISING OUT OF OR RELATED TO, DIRECTLY OR INDIRECTLY, ANY BREACH OF ANY PROVISION OF ANY AGREEMENT BETWEEN ALLTRADE AND/OR ITS REPRESENTATIVE(S) AND PURCHASER, ANY WARRANTY HEREUNDER, AND/OR THE EXISTENCE, DESIGN, MANUFACTURE, PURCHASE, USE AND/OR OPERATION OF ANY ITEM(S) SOLD HEREUNDER EVEN IF ALLTRADE AND/OR ITS REPRESENTATIVE(S) HAS BEEN ADVISED OF THE POSSIBILITY OF ANY SUCH DAMAGES. IN NO EVENT, WHETHER AS A RESULT OF A BREACH OF CONTRACT, WARRANTY, TORT (INCLUDING NEGLIGENCE) OR OTHERWISE, SHALL ALLTRADE'S AND/OR ITS REPRESENTATIVE(S) LIABILITY EXCEED THE PRICE OF THE PRODUCT. ANY AND ALL LIABILITY CONNECTED WITH THE USE OF THIS PRODUCT SHALL TERMINATE UPON THE EXPIRATION OF THE WARRANTY PERIODS SPECIFIED ABOVE.

Limitations on Warranty Disclaimers

Some states do not allow limitations on how long an implied warranty lasts and some states do not allow the exclusion or limitation of the incidental or consequential damages, so part or all of the above limitations or exclusions may not apply to you. This warranty gives you specific legal rights, and you may also have other rights which vary from state to state.

If your product is not covered by this warranty, please call our Customer Service Department toll free at 1-800-590-3723 for general repair information and charges.